



baja designs[®]
THE SCIENTISTS OF LIGHTING

2024-on Toyota Tacoma A-Pillar Kits

(44-8241 thru 44-8245, 44-8251, 44-8264 thru 44-8269)



2950 Norman Strasse San Marcos, CA 92069

Phone 760-560-2252 X3 • Fax 760-560-0383

info@bajadesigns.com • www.bajadesigns.com



baja designs[®]
THE SCIENTISTS OF LIGHTING

LIMITED LIFETIME WARRANTY

Baja Designs proudly offers a LIFETIME WARRANTY against manufacturer's defect on all the products that we manufacture.

These are comprehensive warranties; other than the exclusions below – you're covered. If your LED or HID bulb burns out, you're covered. Additionally, cutting off our connector or changing your lenses does not automatically void your warranty.

Exclusions:

Installation errors, abuse, misuse, or crash damage. You must be the original owner of the product and can supply proof of purchase.

Baja Designs manufactures its own products as well as resells products manufactured by others. Baja Designs makes no express or implied warranties on products not manufactured by Baja Designs including without limitation any warranties or merchantability and fitness for a purpose. We will, however, pass on all warranties made by the manufacturer, who has sole responsibility for performing such warranties.

Baja Designs will pay the freight if your product is less than 90 days old, otherwise defective products must be returned to Baja Designs, Inc., freight prepaid. At our option, we will repair or replace items in question and return them at no charge. If the identical product is no longer available, we will replace it with a similar product of equal value. Baja Designs Inc. will not be responsible for any indirect or consequential damages in connection with defective merchandise.

Items purchased through a Baja Designs authorized dealer must be returned through the dealer. Only available on LED auxiliary lights and product must be in sellable condition at MSRP. Product that has been damaged in any way after the original purchase date will be excluded from this guarantee.

Indemnification:

Buyer hereby acknowledges off-roading, racing and driving at night are dangerous activities and that the products and/or supplies purchased from Baja Designs are used in an inherently dangerous activity that may endanger life and limb; and in no event shall the seller, or seller's heirs and assigns, be held liable for consequential damages, nor shall seller's liability on any claim for damages arising out of or connected with the sale, delivery, or use of purchased products and/or supplies exceed the purchase price of the products and/or supplies.

Buyer is responsible for ensuring that it uses the products (and its vehicle) in accordance with all applicable laws, regulations, guidelines, and standards of care. Buyer acknowledges that some products may only be used when off-roading, and Buyer will comply with all vehicle and road safety guidelines. Buyer is solely responsible for (and will indemnify and hold Bestop harmless for) any claims, losses, damages, fines, fees, costs, or other amounts arising out of Buyer's non-compliance with these provisions.

****For a color copy of instructions, visit your vehicle specific application on BajaDesigns.com ****

Required Tool(s):

- Sockets: 10mm, 12mm, 7/16"
- Wrenches: 7/16", (2) 9/16"
- Hex Tool: 4mm, 6mm Hex Tool
- Misc Tool: Masking tape, 3/4" Step Drill Bit

Parts List:

 <p>(44-9441) (Qty: 1) 24 Tacoma A-pillar Bracket DS</p>	 <p>(44-9442) (Qty: 1) 24 Tacoma A-pillar Bracket PS</p>	 <p>(20-1022) (Qty: 4) 8mm Flat Washer</p>	 <p>(20-1236) (Qty: 4) M8x25 Socket Cap Screw</p>
 <p>(20-1612) (Qty: 8) 8" Zip-tie</p>	 <p>(Qty: 1) Squadron Pair (Squadron Kit Only)</p>	 <p>(Qty: 1) XL Pair (XL Kit Only)</p>	 <p>(Qty: 1) LP4 Pair (LP4 Kit Only)</p>
 <p>(64-0117) (Qty: 1) Squadron Pair Harness (in Squadorn Pair Box)</p>	 <p>(64-0121) (Qty: 1) XL Pair Harness (in XL Pair Box)</p>	 <p>(64-0175) (Qty: 1) LP4 Pair Harness (in LP4 Pair Box)</p>	 <p>(64-0176) (Qty: 1) LP4 Backlight Harness (in LP4 Pair Box)</p>
 <p>(60-0101) (Qty: 1) Upfitter Pigtail (Upfitter Upgrade Only)</p>			

To begin, make sure the vehicle is in park, on level ground and the parking brake is engaged.

Step 1: Open the hood and mark the hood hinge alignment on the hood. With a 12mm socket, remove the front bolt holding the hood to the driver side (DS) hood hinge. Replace it using a 6mm hex tool and the included M8 socket cap screw and washer. Repeat with the rear bolt.



Step 2: Loosen the bolts and slot the DS bracket between the washers and hood hinge and tighten the bolts using the 6mm hex tool. Make sure the hood alignment has not shifted. If misalignment occurs, attempt to realign the two by using the paint marks between the hood and the hinge. Repeat steps 1 and 2 on the PS of the vehicle.



Step 3: For XLs and LP4s: Place the 3/8" bolt and washer through the universal bracket and attach it to the light using a 7/16" socket and the hardware provided (1).

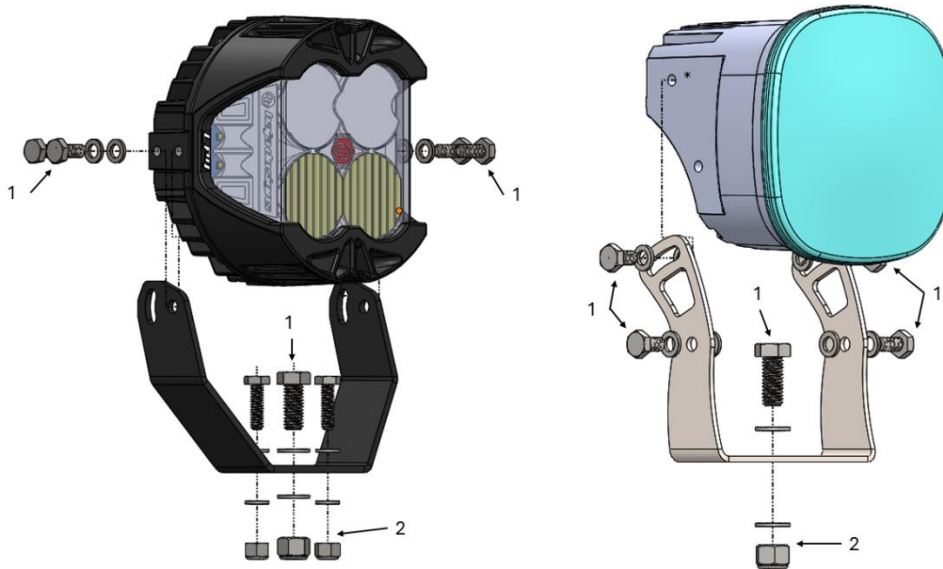

For Squadrons: Place the 3/8" bolt and washer through the universal bracket and attach it to the light using a 4mm hex tool and the hardware provided (1).

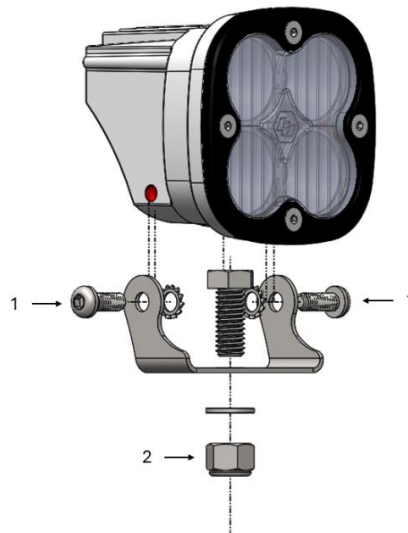

For all kits: Attach the light to the A-Pillar bracket with the 3/8" washer and nut using two 9/16" wrenches (2). Placing painters' tape or a rag on the hood underneath the bracket's light mounting holes is recommended to avoid scratches. Repeat steps 1 and 3 on the passenger side (PS).



Step 4: Using a 10mm socket, disconnect the negative battery cable. Locate the included harness and attach the positive ring terminal to the positive battery post using a 12mm socket. **(for hybrids, refer to hybrid instructions)** Secure the relay near the battery.



Step 5: Route the light leads to the lights and plug them in. The wires should be routed so the connectors are inside the engine bay when the hood is closed. Route the switch lead across the fire wall to the driver side of the vehicle.

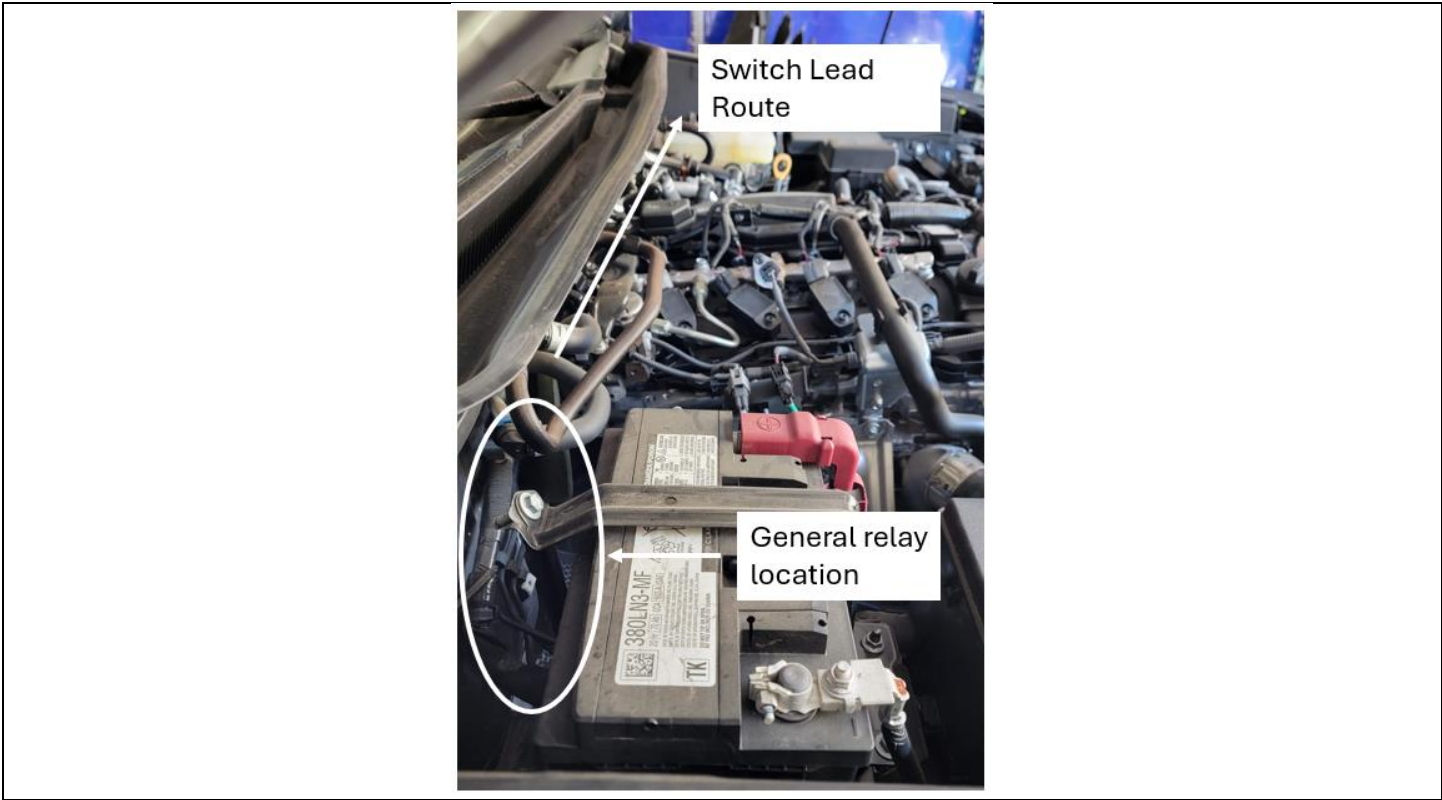

Step 6: (Toggle harness only) Disconnect the white connector on the switch lead and remove the connector from the switch side leaving the pins exposed.

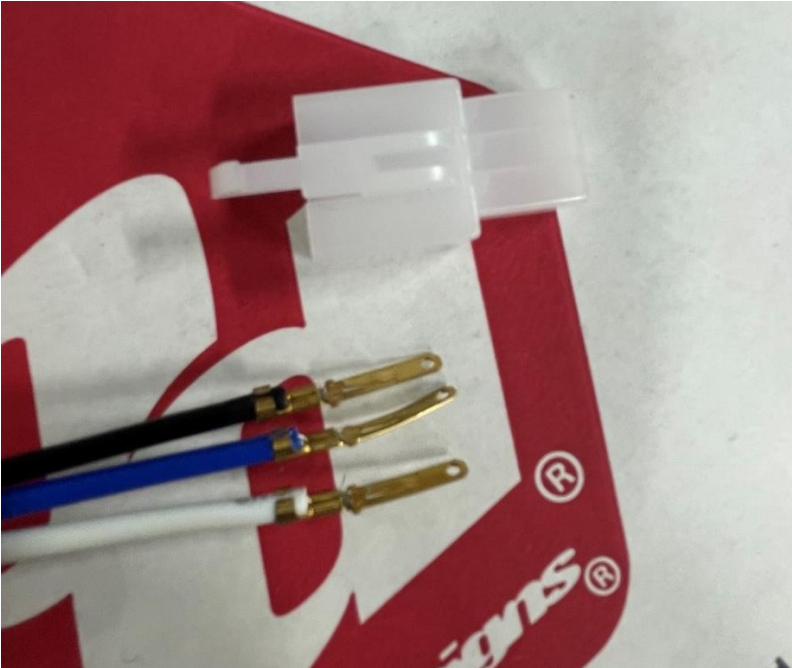

Make a small hole in the firewall passthrough and pass the switch lead connector through the boot into the engine bay (pin side first).



Pull the switch lead into the engine bay until it is long enough to be reconnected to the original harness. Re-install the white connector onto the exposed pins using the format below and then reconnect the two harnesses.

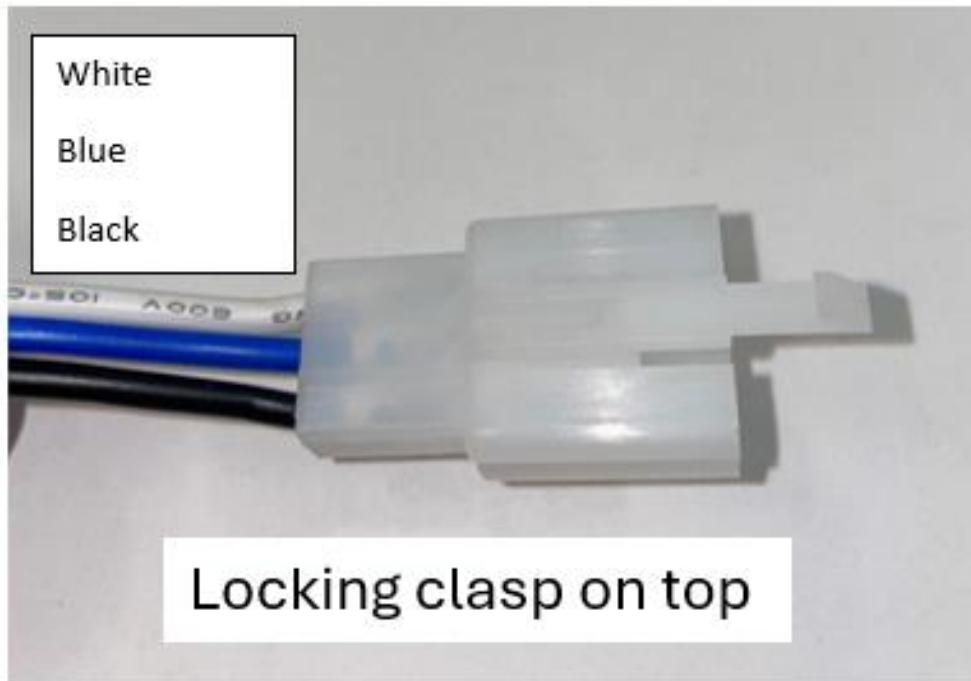

Step 7: (Toggle Harness Only) Remove the door seal on the driver's side and the round trim panel pictured below.

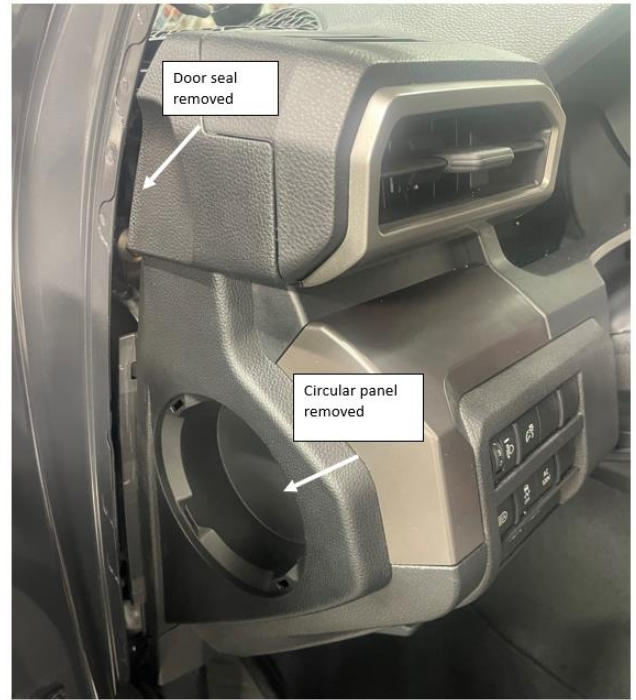
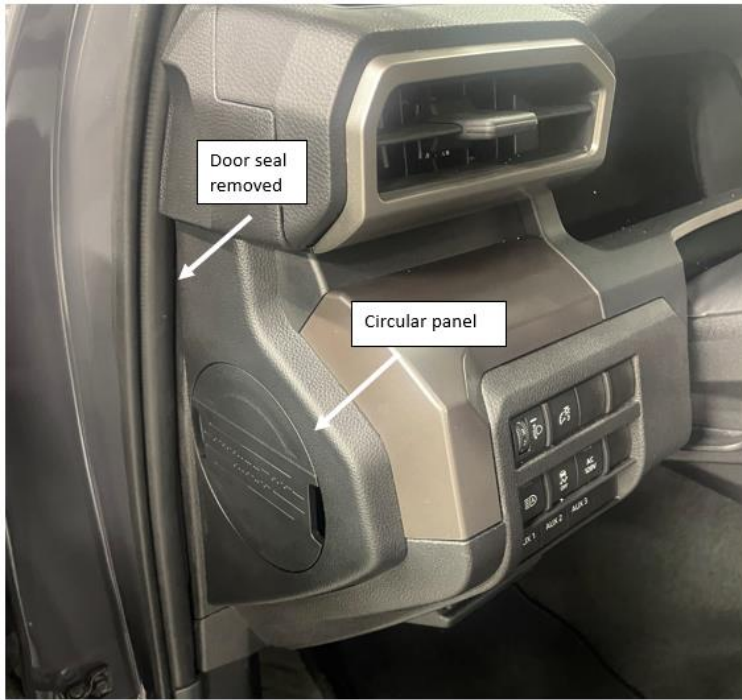

Remove the trim panel off the side of the dashboard by starting at the top edge and gently pulling away from the dash. Remove the chrome trim panel by pulling parallel to the arrows pictured.

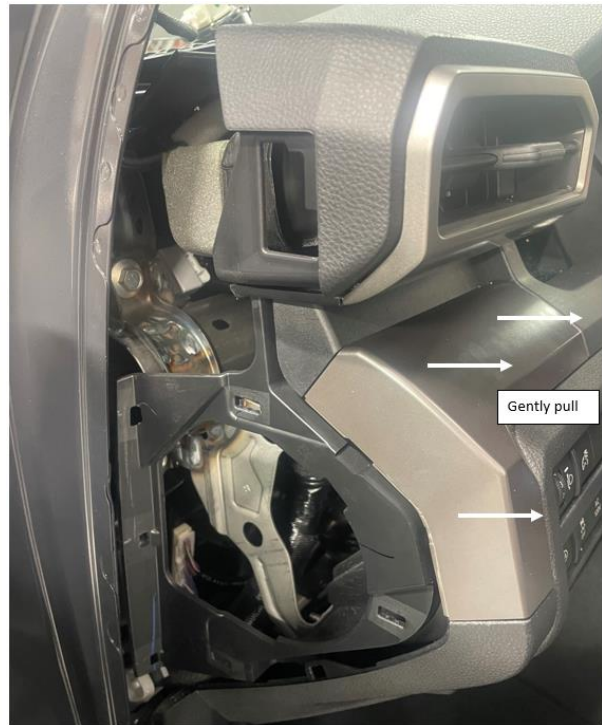
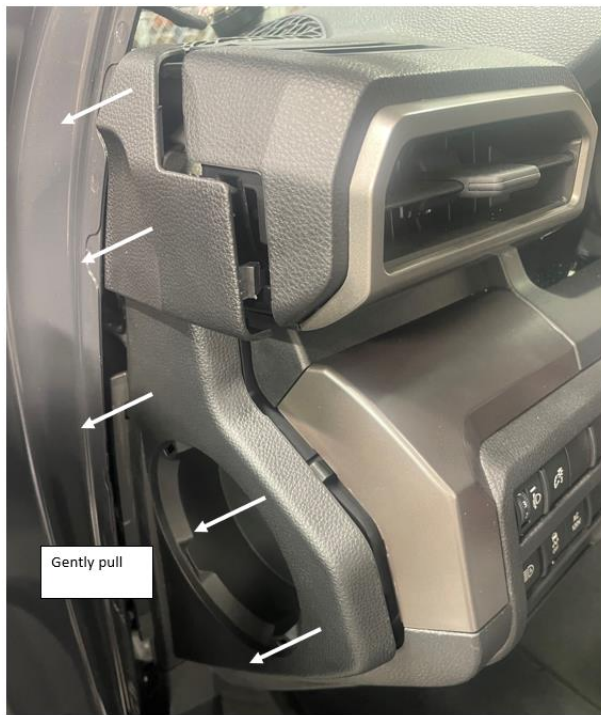

Drill a hole 3/4" diameter at the location specified. Remove the button from the switch harness leaving only the exposed pins. Run the harness up from the footwell behind the dash and into the newly made hole. Re-install the button onto the harness and place it into the dashboard. Re-install all trim panels.

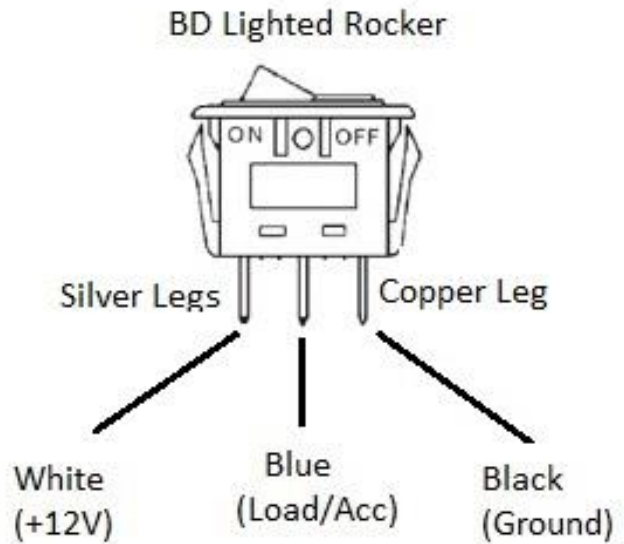

Step 9 Upfitter Upgrade: If the Upfitter Harness Upgrade (60-0101) was purchased, Connect the harness to the AUX 5-pin connector right behind the left front headlight (next to connector in last step) shown at position (G).

Disconnect the white switch plug from the Off/ On Harness (64-0139) and connect the upfitter harness in place of the toggle switch (H).

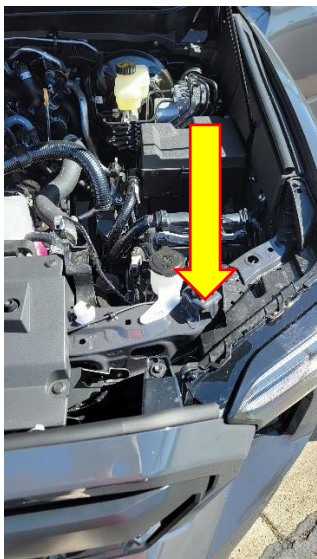

(G)

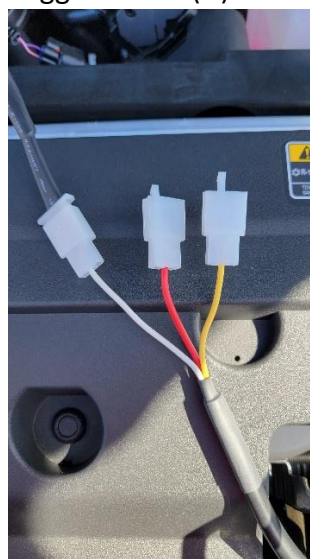

(H)

AUX SWITCH WIRE COLORS:

AUX 1 = Red

AUX 2 = Yellow

AUX 3 = White

All OEM switches are found on the dashboard of the vehicle.

Step 9: Hybrids Only

Remove the passenger side fuse panel cover and locate the positive battery wire and post (boxed). Using a 12mm socket, remove the nut holding down the wire and release the tab to the right of the post. Lift to remove the wire and plastic wire cover.



Twist to pull apart the top of the plastic cable cover until it resembles the photo below. Using a flat head screwdriver, release the 2 tabs on the bottom of the plastic wire cover until the two halves separate and remove them from the wire. Discard the piece that the wire terminal runs through. Replace the battery cable and install the positive (red) ring terminal of the main wiring harness onto the post. Replace the upper battery cable cover, reinstall the 12mm nut and replace the fuse box cover.



Step 10: LP4 Backlight Only

1. Open the driver side fuse box located near the ABS pump (circled). Find the ignition pin shown in photo 1. (On the fuse map it is a 10-amp fuse labeled IGN.)



2. Remove the 10-amp fuse and insert the fuse tap into the slot. Insert the 10-amp fuse in the open spot in the fuse tap. Run the wires out of the fuse box and replace the cover.

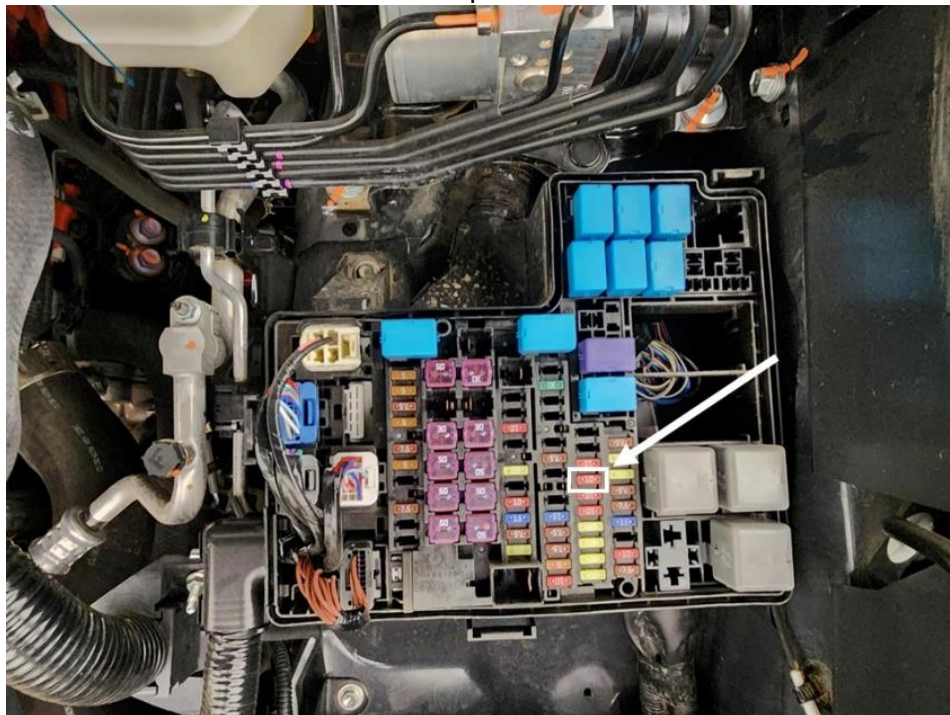

3. Run the shorter of the two wires to the driver side light and the longer wire along the firewall to the passenger side light.



4. Using a flathead screwdriver, remove the green cover on the front of the Deutsch connector of the main harness. Insert the wire into the #3 position until it clicks into place and replace the cover. Repeat for the other light. Tie all excess wire into a service loop.

LP4 Pro Edition

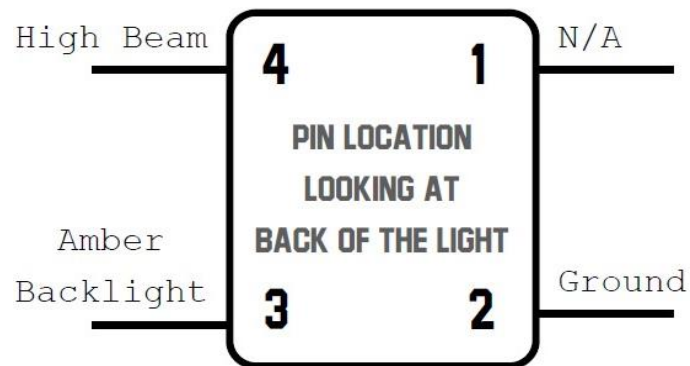

Step 11: LP4 IPT Blockers Only

1. Peel back the white side of the sticker. Apply the white side of the sticker to the IPT cover.

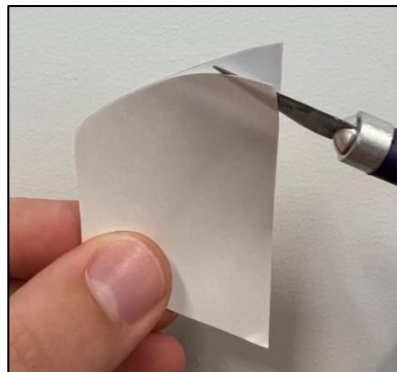

2. Once sticker is applied to the IPT cover, peel back the brown 3M side of the sticker. Before applying the IPT cover to the outside of the lens. Push the IPT cover to the edges of the light housing then apply pressure to the IPT cover to secure the cover to the lens. (this light will be mounted on your passenger side)

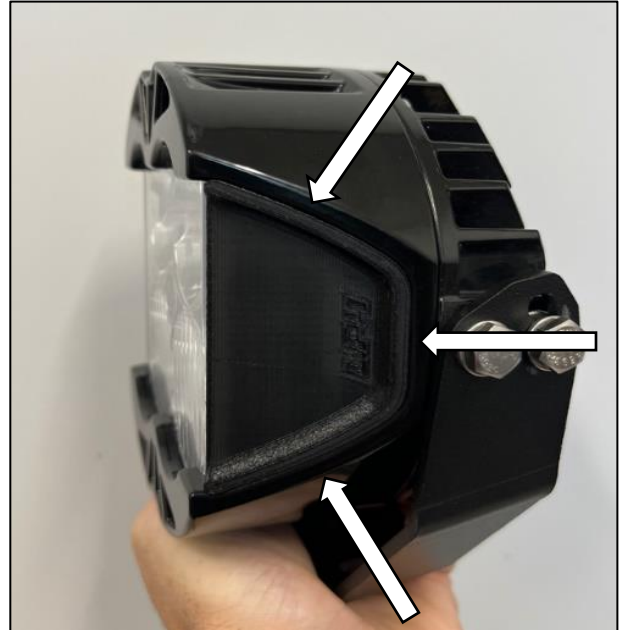

3. Repeat for the other light. Be sure to apply your covers as shown in the photo.



Step 12: Re-connect the vehicle battery and connect the negative wire from the light harness onto the negative battery terminal using a 10mm socket.

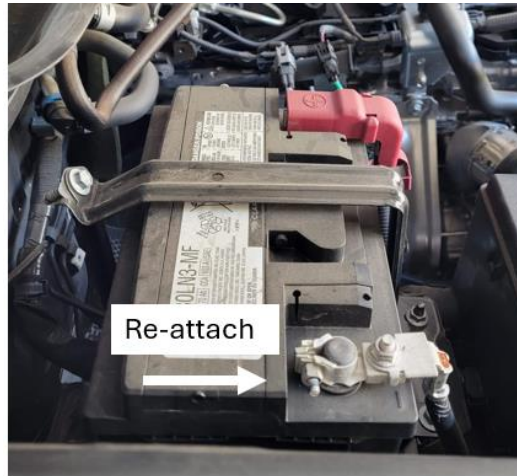

- *Tie all wires away from sharp, hot, and/or rotating components.
- * Re-torque all the fasteners after 100 miles.
- *Your install is now complete! Thank you for choosing Baja Designs.